

LUTRON QED 64 - ROLLER SHADE FABRIC WIDTH & LIGHT GAP OPTIONS

DESIGNER NOTE

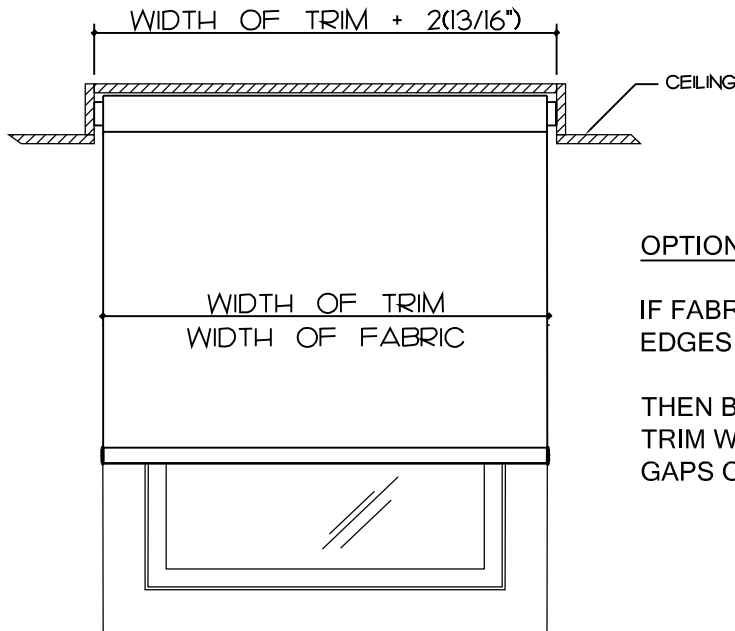

OPTION 1:

IF FABRIC EDGES ALIGN WITH TRIM EDGES

THEN BOX WIDTH EQUALS THE TRIM WIDTH PLUS 13/16" LIGHT GAPS ON EACH SIDE.

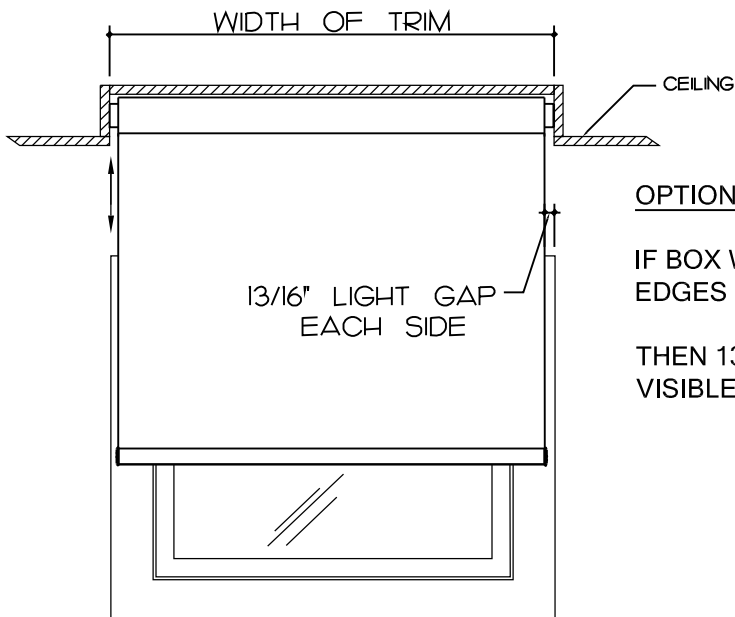

OPTION 2:

IF BOX WIDTH ALIGNS WITH TRIM EDGES

THEN 13/16" OF TRIM WILL BE VISIBLE ON BOTH SIDES.



THE BOSTON SHADE COMPANY

TITLE:
LUTRON QED 64 FABRIC WIDTH OPTIONS

DATE:08/01/09
SCALE: NTS
DRAWN:EU

SKETCH NUMBER

64.7

THE BOSTON SHADE COMPANY
840 SUMMER STREET SUITE 205,
BOSTON, MA 02127 T. 617.268.7460 F. 617.268.7461